

# AEOLUS™ CO<sub>2</sub>/Non-CO<sub>2</sub> Compact Incubator Shakers (3mm, 25mm or 50mm Orbit Models)



# AEOLUS™ CO<sub>2</sub>/Non-CO<sub>2</sub> Compact Incubator Shakers (3mm, 25mm or 50mm Orbit Models)

The CO<sub>2</sub> Compact Incubator Shaker features Temperature, Shaking, CO<sub>2</sub> Concentration, and Humidity controls. With 3mm, 25mm and 50mm orbit models available, its stackable design helps maximize floor space, with the capability of stacking up to three units high.



## PRODUCT FEATURES

- 7" High-Res Color Touch Screen with intuitive graphic interface
- Innovative chamber design features smooth rounded internal corners for easy cleaning
- Infra-Red(IR) CO<sub>2</sub> sensor for precise and reliable CO<sub>2</sub> detection
- Optional WiFi and RS485 control
- UV lights for easy sterilization
- Audible and visual alarms
- Mirror finish, pharmaceutical grade stainless steel chamber
- Stackable design up to 3 units.
- 3mm, 25mm and 50mm orbit models available

## Innovative Design

- Three axis eccentric balance system provides stable and reliable shaking
- Terminal feedback system ensures precise shaking speed
- Sealed Magnetic Drive is highly efficient, quiet, durable, and produces negligible heat that does not affect the chamber temperature
- Combination of Proportional-Integral-Derivative control and Fuzzy control for temperature ensure temperature accuracy within  $\pm 0.1^{\circ}\text{C}$
- Program mode allows user to set up to 12 segments of varying temperature and speed
- Highly efficient inverter compressor refrigeration allows for temperatures as low as 18°C below room temperature with low energy consumption (minimum temperature of 4°C)
- Infrared CO<sub>2</sub> sensor provides accurate and reliable CO<sub>2</sub> detection (IS-ACMA, IS-A5CMA and IS-AHC3SA only)
- Intuitive 7" capacitive touchscreen makes many functions, such as setting alarm parameters, easy to complete
- Slide rail platform makes it easy to load and unload fixtures (except 3mm orbit models)
- Noise reduction design keeps the instrument noise level to 55 dB
- Optional wifi monitoring allows the user to stay in touch with the instrument even outside of the lab

# AEOLUS™ CO2/Non-CO2 Compact Incubator Shakers (3mm, 25mm or 50mm Orbit Models)

## CAPACITIVE TOUCH SCREEN DISPLAY

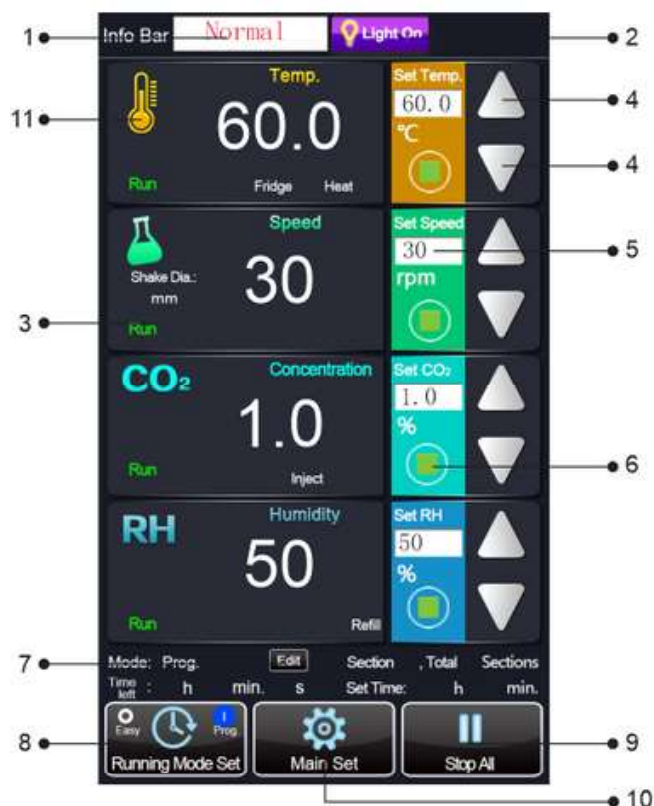

### Main Interface:

1. Displays the current instrument status.
2. Light button: Press to turn the light on or off.
3. Displays the current function's running status, orbit diameter (for speed), and any alarms.
4. Plus and Minus buttons: Adjusts the corresponding function's value.
5. Displays the set value and allows user to manually input the set value.
6. Run/Stop button: Runs and stops function.
7. Edit button for programmable mode: Sets up to 12 running segments of varying temperatures and speed.
8. Running mode button: Switches between "Easy" and "Program Control" mode.
9. Run/Stop all button: Runs and stops all functions.
10. Main Settings button: Enters settings page (image below), which features specific settings for the user to edit.
11. Function icon buttons: Graphically displays the real-time function data.

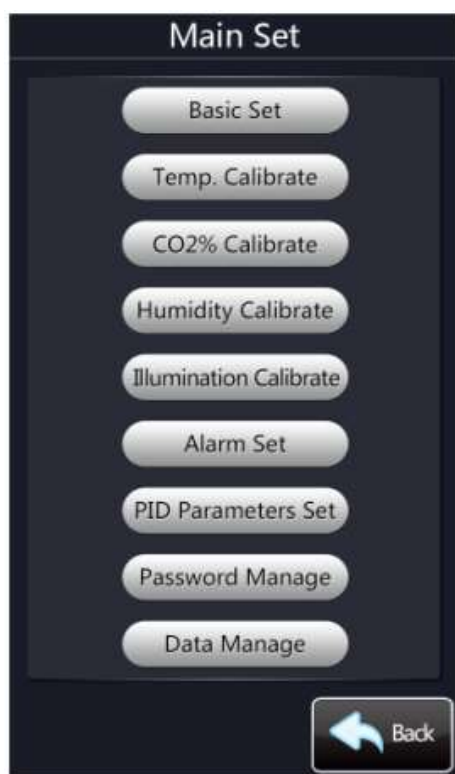

### Control Features

- Powerful Data storage: Data is stored for more than 2 years. Recorded in 1 minute intervals.
- Real-time data view: On the display, operator can view the running data from latest 7 days.
- Data export: Easily export more than 2 years of parameter data via USB.
- Optional Remote WiFi monitoring accessory and smart phone app enable remote monitoring and control.
- Various Alarms: Alarms can be set to activate when parameter values deviate outside of users' set ranges.
- Alarm recording: Alarm information is stored and viewable.
- Easy Calibration: Calibrating functions only require inputting the difference between set and actual values.

# AEOLUS™ CO2/Non-CO2 Compact Incubator Shakers (3mm, 25mm or 50mm Orbit Models)

## REMOTE MONITORING APP

Crystal Industries' Remote Monitoring accessory and app gives customers the ability to control their incubator right from their phone or tablet via Wifi Connection. Features of the incubator app include the ability to set and change the incubator's parameters (including temperature and CO2 concentration). Text notification are sent when an alarm is activated. This unique app makes it possible to stay conveniently connected with CTI incubator and ongoing projects, whether you are in the lab or not.

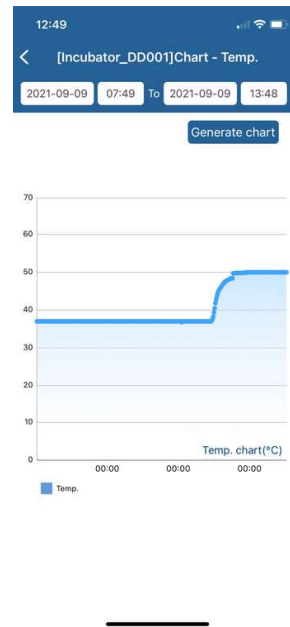
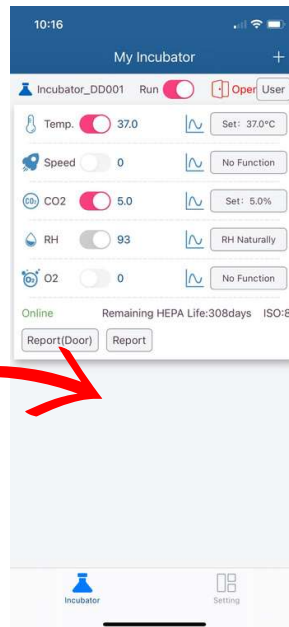
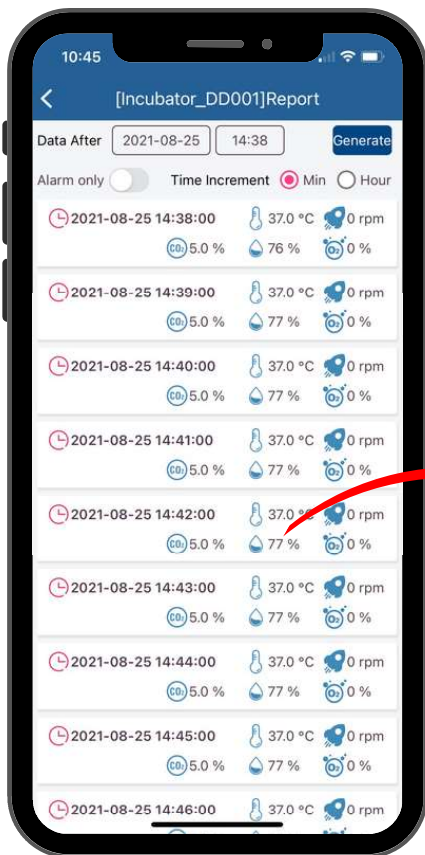
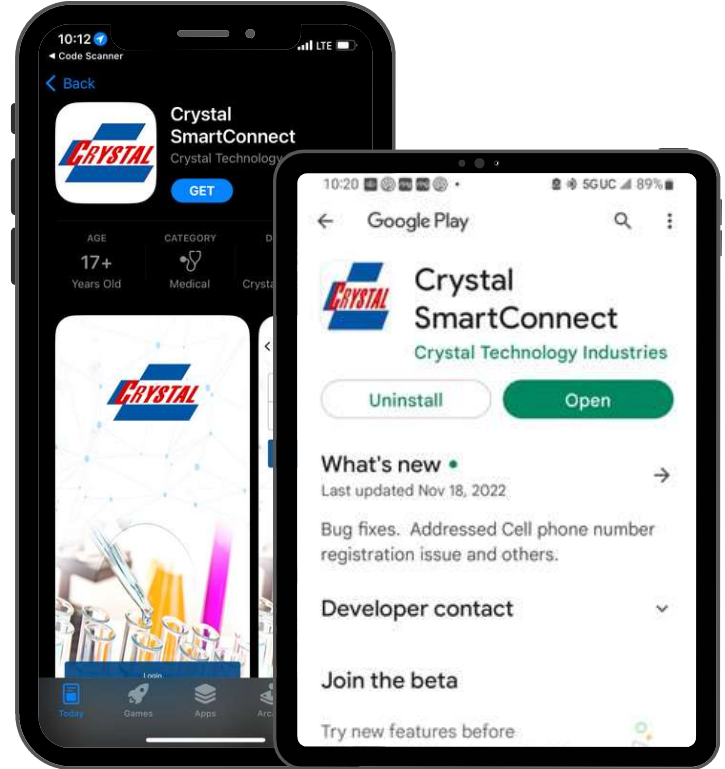

# AEOLUS™ CO<sub>2</sub>/Non-CO<sub>2</sub> Compact Incubator Shakers (3mm, 25mm or 50mm Orbit Models)

## OVERVIEW

- **High Resolution 7-inch Color Touch Screen:** Modular display presents instrument status and function values in a clear and concise manner.
- **Capacitive Touch Screen:** The capacitive screen is more responsive and durable than a resistance screen as there is no reaction delay when the screen is pressed.
- **Screen Lock:** The display screen has an automatic lock screen with password protection function. This prevents any accidental or unauthorized alterations of the programmed operations or settings.
- **Pull Out Rail Platform:** Operators can easily pull the platform out to load or unload fixtures. Only one locking handle in the middle of the platform makes the process fast and convenient (except the 3mm orbit models).
- **Sealed Magnetic Drive:** All models are beltless for longer life and lower maintenance.
- **Excellent Temperature Control Performance:** When the incubator is at a stable temperature of 37°C, the uniformity is  $\pm 0.3^{\circ}\text{C}$ .
- **Strong Cooling Capacity:** The incubator chamber can be cooled to 18°C below the ambient temperature (Lowest temp is 4°C).
- **Inverter Compressor:** Makes cooling a noiseless, durable, and highly efficient process while also saving energy.
- **Three Units Can Be Stacked:** This product can be purchased as a single, double, or triple stack.
- **Bi-Directional Ultraviolet Sterilization:** The chamber is equipped with UV sterilization light components to enhance the germicidal irradiation effect and reach all areas of the chamber.
- **Ultra Quiet Design:** The noise level is less than 55dB when incubator is running and cooling (loudest process), providing a quiet environment for the operator.
- **Slow Acceleration and Deceleration:** Shaking function starts and stops slowly to prevent large shear forces on the bacteria or cells.
- **High Pressure Water Rinse:** Both the platform and chamber feature an integrated draining system that is fast and efficient.
- **Efficient and Durable Insulation:** Foamed Polyurethane insulation provides advanced thermal insulation. The material is also air-tight, waterproof, lightweight, shockproof, electrically insulated, heat resistant, cold resistant, and solvent resistant.

# AEOLUS™ CO<sub>2</sub>/Non-CO<sub>2</sub> Compact Incubator Shakers (3mm, 25mm or 50mm Orbit Models)

## PRODUCT DIMENSIONS

Single Unit Dimensions

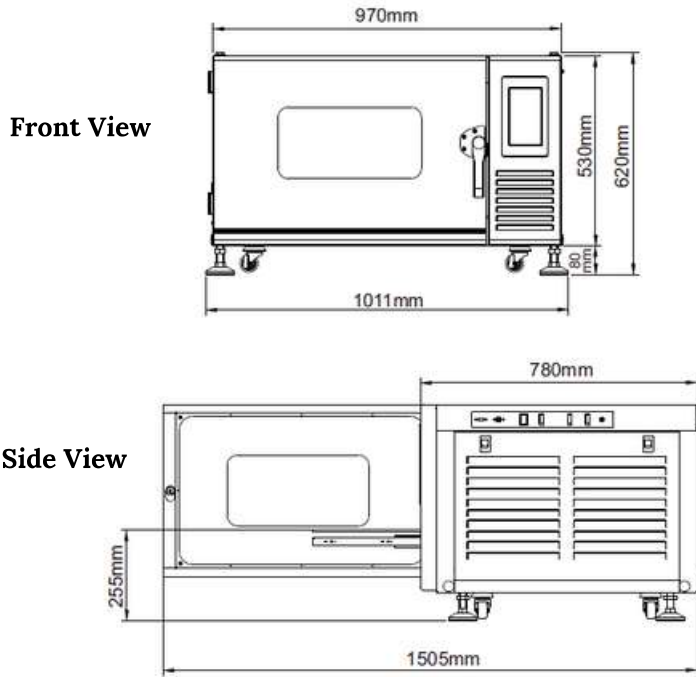

Double Stack Dimensions with IS-A93 Stand

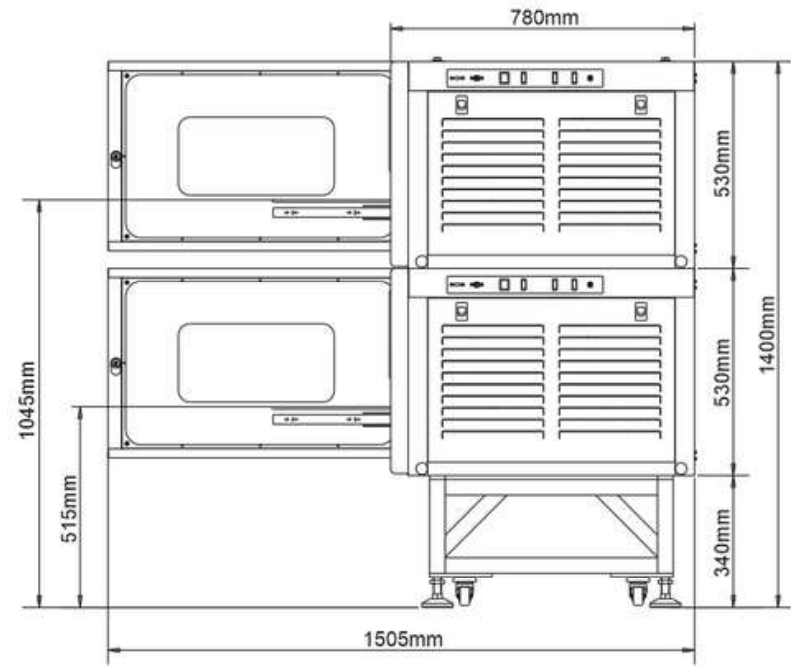

**Side View**

Triple Stack Dimensions

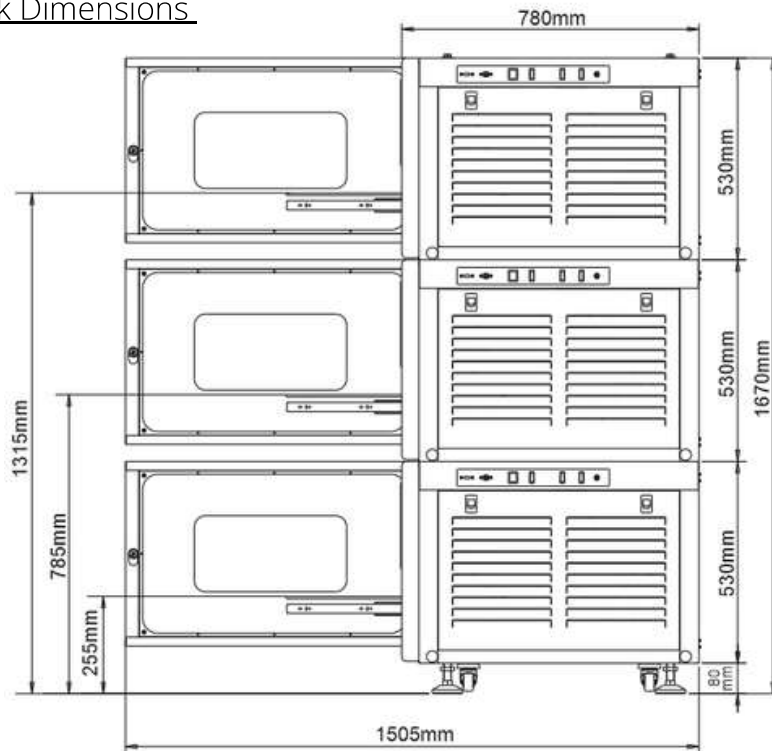

**Side View**



# AEOLUS™ CO2/Non-CO2 Compact Incubator Shakers (25mm or 50mm Orbit Models)

## PRODUCT SPECIFICATIONS

Model	IS-AMA	IS-A5MA	IS-ACMA	IS-A5CMA
Product Name	AEOLUS™ Compact Magnetic Drive Incubator Shaker		AEOLUS™ Compact Magnetic Drive CO2 Incubator Shaker	
Platform Dimensions WxD	550 x 470 mm (21.65 x 18.50 in)			
Max Capacity	Clamp capacity: 50mlx72 / 100mlx30 / 150mlx30 / 200mlx30 / 250mlx30 / 500mlx16 / 1000mlx12 / 2000mlx6 / 5000ml(Thomson)x4 Sticky Mat: 50mlx72 / 100mlx53 / 150mlx41 / 200mlx32 / 250mlx30 / 500mlx16 / 1000mlx12 / 5000ml(Thomson)x4			
Capacity	190 L			
Max Load	10 kg (22.05 lb)			
Temp. Range	Room Temp. Minus 18°C–60°C (Lowest Temp is 4°C)			
Temp Accuracy	±0.1 °C			
Temp. Uniformity	± 0.3°C (@37°C)			
Temp Recover Time After Door is Opened for 30s	≤6min (@37°C)			
Speed	0(stop), 30– 300 rpm			
Speed Accuracy	±1rpm			
Speed Drive	Magnetic Drive			
Orbit Diameter	ø25mm (ø1.02in)	ø50mm (ø2in)	ø25mm (ø1.02in)	ø50mm (ø2in)
CO2 Sensor	N/A		Infrared	
CO2 Control Range	N/A		0–20%	
CO2 Control Accuracy	N/A		±0.1%	
CO2 Recover Time After Door is Opened for 30s	N/A		≤6min (@5%)	
Relative Humidity Type	Active		Active	
Max Humidity	90%		90%	
Programmable Segments	12 Segments			
Timer	0–999h59min			
Illumination	LED Lamps on Left and Right Walls			
Disinfection	UV Lamps on Left and Right Walls			
Door Opening Direction	Leftward			
Internal Dimensions WxDxH	654 x 605 x 474 mm (25.75 x 23.82 x 18.66 in)			
Outside Dimensions WxDxH	970 x 780 x 530(+80 with feet) mm (38.19 x 30.71 x 20.87(+3.15 with feet) in)			
Internal Working Height	300mm (11.8in)			
Net Weight	170 kg (375 lb)			
Display	7" Color Capacitive Touch Screen			
Parameter Protection	Password Protected			
Data Stored	Time, Temperature, Speed, Instrument Status		Time, Temperature, Speed, CO2 Concentration, Humidity, Instrument Status	
Data Storage Interval	1 Minute			
Screen Data Display	Displays Most Recent 7 Days of Data			
USB Data Export	Most Recent 912 Days of Data			
Automatic Defrost	Yes			
Noise Level	≤55dB (When Compressor is Running)			
Auto-Recovery after Power Interruption	Yes			
Power when Heating	≤450 W			
Power when Cooling	≤180W			
Power supply	AC 110V±11V, 60Hz			
Power	≤630W		≤630W	
Mobile Monitoring and Control by WiFi	Optional through IS-A64W Accessory and App			
Warranty	2 Years Parts and Service			
Certification	CE			



# AEOLUS™ CO<sub>2</sub>/Non-CO<sub>2</sub> Compact Incubator Shakers (25mm or 50mm Orbit Models)

## PRODUCT ACCESSORIES



Tube Rack



Adjustable Tube Rack



Multi Micro-Plate holder



Flask Clamps



Mini Universal Spring Platform



96-Well Micro-Plate Holder



Bioreactor Tube Holder



Infusion Bottle Clamp

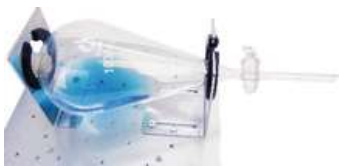

Fixture for Separating Funnel



Sticky Pad



Visor cover



CO<sub>2</sub> Cylinder Pressure Regulator



Stand for AEOLUS Compact Incubator Shakers



Water Carboy



# AEOLUS™ CO<sub>2</sub>/Non-CO<sub>2</sub> Compact Incubator Shakers (25mm or 50mm Orbit Models)

## ACCESSORY SPECIFICATIONS

Item Number	Item Type	Specifications	Max Capacity
IS-A50	Flask Clamp	Holds 25 mL Flask	72
IS-A1		Holds 50 mL Flask	72
IS-A2		Holds 100 mL Flask	30
IS-A3		Holds 150 mL Flask	30
IS-A4		Holds 200 mL Flask	30
IS-A5		Holds 250 mL Flask	30
IS-A6		Holds 500 mL Flask	16
IS-A7		Holds 1000 mL Flask	12
IS-A8		Holds 2000 mL Flask	6
IS-A10		Holds 5000 mL Thomson Flask	4
IS-A11	Tube Rack	Holds 40 Tubes x ø14mm	6
IS-A12		Holds 40 Tubes x ø16mm	6
IS-A23		Holds 40 Tubes x ø18mm	6
IS-A24		Holds 27 Tubes x ø22mm	6
IS-A42		Holds 21 Tubes x ø30mm	6
IS-A20	Adjustable Tube Rack	Holds 40 Tubes x ø14mm	6
IS-A21		Holds 40 Tubes x ø16mm	6
IS-A30		Holds 40 Tubes x ø18mm	6
IS-A31		Holds 27 Tubes x ø22mm	6
IS-A32		Holds 21 Tubes x ø30mm	6
IS-A37		Holds 24 Tubes x ø30mm	3
IS-A33	Infusion Bottle Clamp	Holds 500 mL Infusion Bottle	21
IS-A34		Holds 1000 mL Infusion Bottle	13
IS-A13	Microplate Holder	96-Well Microplate Holder	18
IS-A175	Multi-Microplate Holder	Holds up to 6 Standard Microplates	18
IS-A35	Fixture for Separating Funnel	Holds Separating Funnels of ≥500mL	3
IS-A47	Sticky Mat	140 x 140mm	12
IS-A122	Sticky Mat	550 x 470mm	2
IS-A96	Spring Frame	550 x 470 x 80 mm	1
IS-A27		350 x 240 x 80 mm	4
IS-A22		450 x 400 x 80 mm	1
IS-A14		428 x 295 x 80 mm	2
IS-A90	Water Carboy	For IS-ACMA humidity function Holds 15L 1 can serve up to 3 incubator shakers	1
IS-A93	Stand	Adds 340 mm (13.39in) of height <b>Recommended for use with single and double stacks</b>	1
IS-A95	Visor Cover	Blocks ambient light from entering chamber	1
IS-A64W	Remote Monitoring and Control	Connects each unit to users' phones via a wifi or wired internet connection and an app available on the Apple Store and Google Play	1
CIA25	CO <sub>2</sub> Cylinder Pressure Regulator	Max Inlet Pressure: 3000 psi Max Outlet Pressure: 60 psi	1 (up to 2 Units)
IS-A166	Bioreactor Tube Holder	Holds 450/500mL Bioreactor Conical Tubes	3
IS-A178		Holds 600mL Bioreactor Conical Tubes	3

**NOTE:** 3000mL flask clamps (IS-A9) are available for use with 2.8L Fernbach flasks. Flasks must be shorter than the working height of the incubator shaker chamber (300mm).



# AEOLUS™ IS-AHC3SA/IS-AH3GA Compact CO<sub>2</sub>/Non-CO<sub>2</sub> Stackable Incubator Shakers for Microplates (3mm Orbit)

The Compact CO<sub>2</sub>/nonCO<sub>2</sub> Microplate Incubator Shakers feature a 3mm orbit, optimized for thorough mixing of microplates and deep-well microplates with variable shaking speeds of 150-1000 rpm for gentle mixing to ensure the well contents remain in place or for more vigorous agitation for effective aeration across the small surface area of each of the wells.

## Microplate Platform Options:

### *For Shaking Microplates or Deep-well Plates at speeds of 150-1000 rpm*

The IS-A152 Platform pre-installed in each unit with optional IS-A157 Column Clamp Pressure Pads (blue) and IS-A158 Silicon Pads accessories (purchased separately)

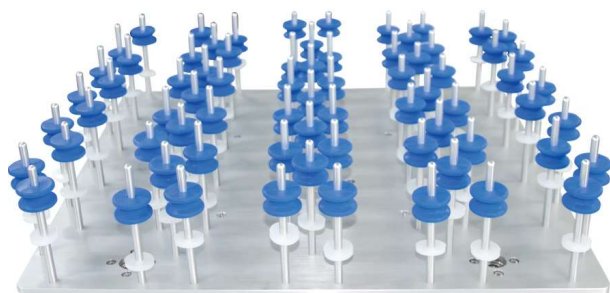

**Holds 60 Microplates  
(3 layers x 20 Microplates)**

**OR**

**Holds 40 Deep-well Plates  
(2 layers x 20 Deep-well Plates)**

### *For Shaking Deep-well Plates at speeds of 150-1000 rpm*

The IS-A119 Aluminum Platform with optional IS-A167 Deep-Well Plate Holders (purchased separately) offers convenient, fast loading and unloading of plates.

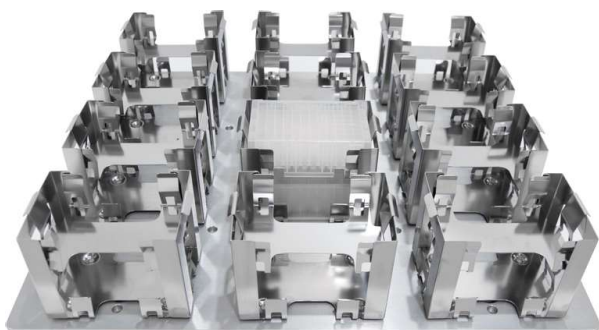

**Holds 12 sets of Double-Layer  
Deep-Well Holders  
(24 Deep-Well Plates total)**

# AEOLUS™ IS-AHC3SA/IS-AH3GA Compact CO2/Non-CO2 Stackable Incubator Shakers for Microplates (3mm Orbit)

## PRODUCT SPECIFICATIONS

Model	IS-AH3GA	IS-AHC3SA
Product Name	180L Compact Magnetic Drive Incubator Shaker, Microplates	180L Compact Magnetic Drive CO2 Incubator Shaker, Microplates
Platform Dimensions WxD	570 x 500 mm	
Max Capacity	Microplate: 3 x 20 Plates, Deepwell Plate 2 x 20 Plates	
Capacity	180L	
Max Load	10 kg (22.05 lbs.)	
Temp. Range	Room Temp. Minus 18°C-60°C (Lowest Temp is 4°C)	
Temp Accuracy	±0.1 °C	
Temp. Uniformity	± 0.3°C (@37°C)	
Temp Recover Time After Door is Opened for 30s	≤6min (@37°C)	
Speed	0(stop), 150~1000 rpm	
Speed Accuracy	±1rpm	
Speed Drive	Magnetic Drive	
Orbital Diameter	3mm	
CO2 Sensor	N/A	Infrared
CO2 Control Range	N/A	0~20%
CO2 Control Accuracy	N/A	±0.1%
CO2 Recover Time After Door is Opened for 30s	N/A	≤6min (@5%)
Relative Humidity Type	Active	Active
Max Humidity	90%	90%
Programmable Segments	12 Segments	
Timer	0~999h59min	
Illumination	LED Lamps on Left and Right Walls	
Disinfection	UV Lamps on Left and Right Walls	
Door Opening Direction	Leftward	
Internal Dimensions WxDxH	654 x 605 x 292 mm (25.75 x 23.82 x in)	
Outside Dimensions WxDxH	970 x 780 x 530(+80 with feet) mm (38.19 x 30.71 x 20.87(+3.15 with feet) in)	
Internal Working Height	290mm	
Net Weight	195kg	
Display	7" Color Capacitive Touch Screen	
Parameter Protection	Password Protected	
Data Stored	Time, Temperature, Speed, Instrument Status	Time, Temperature, Speed, CO2 Concentration, Humidity, Instrument Status
Data Storage Interval	1 Minute	
Screen Data Display	Displays Most Recent 7 Days of Data	
USB Data Export	Most Recent 912 Days of Data	
Automatic Defrost	Yes	
Noise Level	≤55dB (When Compressor is Running)	
Auto-Recovery after Power Interruption	Yes	
Power when Heating	≤450 W	
Power when Cooling	≤180W	
Power supply	AC 110V±11V, 60Hz	
Power	≤630W	≤630W
Mobile Monitoring and Control by WiFi	Optional through Accessory and App	
Warranty	2 Years Parts and Service	
Certification	CE	



# AEOLUS™ IS-AHC3SA/IS-AH3GA Compact CO2/Non-CO2 Stackable Incubator Shakers for Microplates (3mm Orbit)

## PRODUCT ACCESSORIES

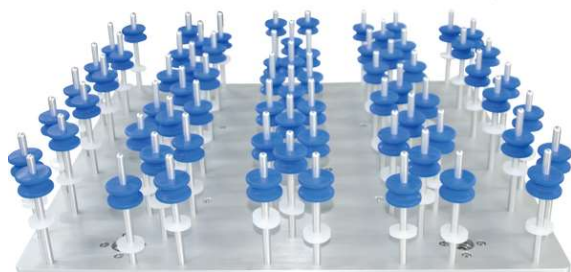

**Platform with Pre-Installed Deep-Well Plate Holders (IS-A152)**  
(Set of 73 Pressure Pads and Silicon Pads included with unit)

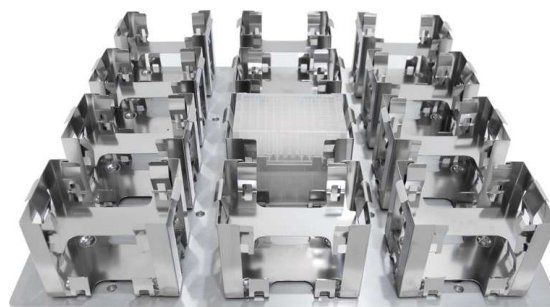

**Platform (IS-A119) with Double-Layer Deep-Well Plate Holders (IS-A167)**  
(IS-A167 Deepwell Plate Holders sold separately)



**Pressure Pad for Microplate Holder (IS-A157)**



**Silicone Pad for Microplate Holder (IS-A158)**



**Visor cover**



**Water Carboy**



**CO2 Cylinder Pressure Regulator**



**Stand for AEOLUS Compact Incubator Shakers**



# AEOLUS™ IS-AHC3SA/IS-AH3GA Compact CO2/Non-CO2 Stackable Incubator Shakers for Microplates (3mm Orbit)

## ACCESSORY SPECIFICATIONS

Item Number	Item Type	Specifications	Max Capacity
IS-A152	Deep Well Plate Holder + Platform	Accommodates 2 layers of deep-well plates; Platform: 500 x 570mm; Column Height: 125mm	1
IS-A167	Double-Layer Deep-Well Plate Holder	Internal Dimensions: 127 x 85 x (25-51)mm; 2 Deep-Well Plates per holder	12 (per IS-A119)
IS-A119	Platform for Deep-Well Plate Holders	Dimensions: 500 x 570mm; Holds 12 sets of Double-Layer Deep-Well Holders or 24 Deep-Well Plates	1
IS-A157	Pressure Pad for Microplate Holder	Thickness: 20mm; Outer Diameter: $\Phi$ 27mm	73
IS-A158	Silicone Pad for Microplate Holder	Thickness 5mm; Outer Diameter $\Phi$ 27mm	73
IS-A93	Stand	Adds 340 mm (13.39in) of height <b>Recommended for use with single and double stacks</b>	1
IS-A90	Water Carboy	For IS-AHC3SA humidity function; Holds 15L; 1 Carboy serves up to 3 incubator shakers	1
IS-A95	Visor Cover	Blocks ambient light from entering chamber	1
CIA25	CO2 Cylinder Pressure Regulator	Max Inlet Pressure: 3000 psi Max Outlet Pressure: 60 psi	1 (up to 2 Units)



# AEOLUS™ CO<sub>2</sub>/Non-CO<sub>2</sub> Compact Incubator Shakers (3mm, 25mm or 50mm Orbit Models)

---



*For over 25 years Crystal Technology and Industries has been driven to deliver exceptional value to the scientific marketplace by developing innovative equipment and Cryo Storage Solutions for today's scientist.*

